

Catalog

# Softstarters Type PSTX and PSTB



# Softstarters type PSTX

## PSTX - The advanced range

Description	4
Overview	6
PSTX and PSTB, Ordering details	8
Accessories, Ordering details	12
Technical data	13
Anybus, Ordering details	18
Wall mounting instructions	19
Dimensions	20
Circuit diagrams PSTX	21
Circuit diagrams PSTB	22
Certifications and approvals	23

# PSTX – The advanced range

## Introduction



The PSTX combines many years of research and product development with extensive knowledge of application specific requirements and needs. It is our latest advancement in motor control and protection and adds new functionality and increased reliability.

- Three-phase controlled
- Operational voltage: 208 – 690 VAC
- Wide rated control supply voltage: 100 – 250 V, 50/60 Hz
- PSTX rated operational current: 30 to 370 A (inside-delta: 640 A)
- Both in-line and inside-delta connection
- Coated circuit boards protecting from dust, moist and corrosive atmosphere
- Detachable keypad rated IP66 (Type 1, 4X,12)
- Graphical display with 14 languages for easy setup and operation
- Built-in bypass for energy saving and easy installation
- Built-in Modbus RTU for monitoring and control
- Support for all major communication protocols
- Analog output for measurement of current, voltage, power factor etc.

## Secure motor Reliability

### Complete motor protection

The PSTX offers complete motor protection in only one unit and is able to handle both load and network irregularities. PT-100, earth fault protection and over/under voltage protection along with many other functions keep your motor safer than ever.

### Three types of current limit

PSTX offers three types of current limit: standard, dual and ramp. This gives you full control of your motor during start. It also allows you to use your motor in weaker networks.

## Improve installation Efficiency

### Built-in bypass saves time and energy

When reaching full speed, the PSTX will activate its bypass. This saves energy while reducing the softstarter's heat generation. On the PSTX, the bypass is built in and verified by ABB, saving you time during installation and space in your panel.

### Easy-to-use and detachable keypad

A user-friendly and clear display saves you time and resources during both setup and operation. The detachable keypad is standard on all PSTX softstarters.

## Increase application Productivity

### Complete control of pumps

Time to use your processes to their full potential. The PSTX features many application enhancing features, including torque control: the most efficient way to start and stop pumps. The pump cleaning feature can reverse pump flow and clean out pipes, securing uptime of your pump system.

### Jog with slow speed

The slow speed forward and backward jog feature will make you more flexible when operating e.g. conveyor belts and cranes. The PSTX provides positioning capabilities, letting you take control of your process.

# PSTX – The advanced range

## Introduction



### Keyhole mounting for quick installation

The PSTX is simple and quick to install using keyhole mounting, saving you valuable time during the installation.

### A compact motor starting solution

When your application reaches full speed, a bypass will reduce the softstarter's energy consumption. It also reduces heat generation which means you can save money by reducing the need of added cooling equipment. On the PSTX, the bypass is built in and verified by ABB.

### Clear markings on the front

With the PSTX, you do not need a manual to handle control circuit connections. With the self-explanatory markings on the front you can verify that the connections are done right. And with basic data on the front, identification is simple without having to take the product down.

### Customizable

The PSTX has 14 pre-installed languages along with options to customize your own specific home screens (up to five different). You can use your customized home screens to show status information important to your process – and hide information that is not.



### Easy to learn

A large graphical display along with built-in assistants make learning how to handle the PSTX fun and simple. The interface resembles other interfaces from ABB which will streamline and help with training of field personnel.

### Detachable

The PSTX comes with a detachable keypad as standard. It can be placed on your panel door, meaning you do not have to interrupt your process in order to read status information or to change settings.

# PSTX – The advanced range

## Overview



PSTX30 ... PSTX105



PSTX142 ... PSTX170

	PSTX30 ... PSTX105						PSTX142 ... PSTX170		
	<b>Softstarter, type</b>								
<b>Normal start</b>	<b>PSTX30</b>	<b>PSTX37</b>	<b>PSTX45</b>	<b>PSTX60</b>	<b>PSTX72</b>	<b>PSTX85</b>	<b>PSTX105</b>	<b>PSTX142</b>	<b>PSTX170</b>
<b>In-line connected</b>									
(400 V) kW	15	18.5	22	30	37	45	55	75	90
IEC, max. A	30	37	45	60	72	85	106	143	171
(440-480 V) hp	20	25	30	40	50	60	75	100	125
UL, max FLA	28	34	42	60	68	80	104	130	169
	<b>400 V, 40 °C</b>								
Using MCCB only, type 1 coordination will be achieved.	<b>MCCB (50 kA), type</b>			T2S160			T3S250		T4S250
To achieve a type 2 coordination, semi-conductor fuses must be used.	<b>Fuse protection (65 kA), Semiconductor fuses, Bussmann, type</b>								
	170M1567	170M1568	170M1569	170M1571	170M1572	170M3819	170M5810	170M5812	
Suitable switch fuse for recommended semi-conductor fuses.	<b>Switch fuse, type</b>		OS32GD03P		OS63GD03P		OS125GD03P		OS250D03P
	<b>Line contactor, type</b>								
The line contactor is not required for the softstarter itself but is often used to open if OL trips	AF30	AF38	AF52	AF65	AF80	AF96	AF116	AF140	AF190
Overload protection is used to protect the motor from over heating	<b>Electronic overload relay</b>								
	Built-in								
The bypass component will reduce the power loss of the softstarter at full speed.	<b>Bypass component, type</b>								
	Built-in								

The table above is an overview of possible combinations of devices.  
Complete coordination tables are available at [www.abb.com/lowvoltage](http://www.abb.com/lowvoltage)

# PSTX – The advanced range

## Overview



PSTX210 ... PSTX370



PSTB470



PSTB570 ... PSTB1050

Softstarter, type									
Normal start In-line connected	PSTX210	PSTX250	PSTX300	PSTX370	PSTB470	PSTB570	PSTB720	PSTB840	PSTB1050
(400 V) kW	110	132	160	200	250	315	400	450	560
IEC, max. A	210	250	300	370	470	570	720	840	1050
(440-480 V) hp	150	200	250	300	400	500	600	700	900
UL, max FLA	192	248	302	361	480	590	720	840	1062
400 V, 40 °C									
Using MCCB only, type 1 coordination will be achieved.									
MCCB (50 kA), type									
	T4S250	T5S400		T5S630		T6S630	T6S800	T7S1250	T7S1600
To achieve a type 2 coordination, semi-conductor fuses must be used.									
Fuse protection (65 kA), Semiconductor fuses, Bussmann, type									
	170M5812	170M5813	170M6812	170M6813		170M8554	170M6018	170M6020 <sup>2)</sup>	
Suitable switch fuse for recommended semi-conductor fuses.									
Switch fuse, type									
	OS400D03P			OS630D03P			OS800D03P	1)	
The line contactor is not required for the softstarter itself but is often used to open if OL trips									
Line contactor, type									
	AF205	AF265	AF305	AF370	AF460	AF580	AF750	AF1350	AF1650
Overload protection is used to protect the motor from over heating									
Electronic overload relay, type									
	Built-in								
The bypass component will reduce the power loss of the softstarter at full speed.									
Bypass component, type									
	Built-in								

<sup>1)</sup> Switch fuse not available. Use Bussmann fuse base 170H3004

<sup>2)</sup> PSTB1050-690-70 has 170M6019



# PSTX30 ... PSTB1050 – The advanced range

## Normal starts, class 10, in-line, ordering details



1SFC132038V0001

PSTX30 ... PSTX105

### Description

Selection table for normal start. Typical applications:

- Bow thruster
- Centrifugal pump
- Compressor
- Conveyor belt (short)
- Elevator
- Escalator

If more than 10 starts/h, select one size larger than the standard selection. For a more precise selection, use the softstarter selection tool available at [www.abb.com/lowvoltage](http://www.abb.com/lowvoltage).



1SFC132039V0001

PSTX142 ... PSTX170



1SFC132036V0001

PSTX210 ... PSTX370



1SFC132039F0002

PSTB470



1SFC132039F0002

PSTB570 ... PSTX1050

### Rated operational voltage $U_e$ , 208-600 V

#### Rated control supply voltage $U_s$ , 100-250 V AC, 50/60 Hz

IEC				UL/CSA				Type	Order code	Weight (1 pce)		
Rated operational power		current		Rated operational power		current				kg	(lb)	
400 V	500 V	690 V		200 / 208 V	220 / 240 V	440 / 480 V	550 / 600 V	FLA				
$P_e$ kW	$P_e$ kW	$P_e$ kW	$I_e$ A	$P_e$ hp	$P_e$ hp	$P_e$ hp	$P_e$ hp					
15	18.5	-	30	7.5	10	20	25	28	PSTX30-600-70	1SFA898103R7000	6.10	(13.45)
18.5	22	-	37	10	10	25	30	34	PSTX37-600-70	1SFA898104R7000	6.10	(13.45)
22	25	-	45	10	15	30	40	42	PSTX45-600-70	1SFA898105R7000	6.10	(13.45)
30	37	-	60	20	20	40	50	60	PSTX60-600-70	1SFA898106R7000	6.10	(13.45)
37	45	-	72	20	25	50	60	68	PSTX72-600-70	1SFA898107R7000	6.10	(13.45)
45	55	-	85	25	30	60	75	80	PSTX85-600-70	1SFA898108R7000	6.10	(13.45)
55	75	-	106	30	40	75	100	104	PSTX105-600-70	1SFA898109R7000	6.10	(13.45)
75	90	-	143	40	50	100	125	130	PSTX142-600-70	1SFA898110R7000	9.60	(21.16)
90	110	-	171	50	60	125	150	169	PSTX170-600-70	1SFA898111R7000	9.60	(21.16)
110	132	-	210	60	75	150	200	192	PSTX210-600-70	1SFA898112R7000	12.70	(27.99)
132	160	-	250	75	100	200	250	248	PSTX250-600-70	1SFA898113R7000	12.70	(27.99)
160	200	-	300	100	100	250	300	302	PSTX300-600-70	1SFA898114R7000	12.70	(27.99)
200	257	-	370	125	150	300	350	361	PSTX370-600-70	1SFA898115R7000	12.70	(27.99)
250	315	-	470	150	200	400	500	480	PSTB470-600-70	1SFA894016R7000	31.00	(68.34)
315	400	-	570	200	250	500	600	590	PSTB570-600-70	1SFA894017R7000	52.00	(114.64)
400	500	-	720	250	300	600	700	720	PSTB720-600-70	1SFA894018R7000	55.00	(121.25)
450	600	-	840	300	350	700	800	840	PSTB840-600-70	1SFA894019R7000	60.00	(132.28)
560	730	-	1050	400	450	900	1000	1062	PSTB1050-600-70	1SFA894020R7000	60.00	(132.28)

### Rated operational voltage $U_e$ , 208-690 V

#### Rated control supply voltage $U_s$ , 100-250 V AC, 50/60 Hz

15	18.5	25	30	7.5	10	20	25	28	PSTX30-690-70	1SFA898203R7000	6.10	(13.45)
18.5	22	30	37	10	10	25	30	34	PSTX37-690-70	1SFA898204R7000	6.10	(13.45)
22	25	37	44	10	15	30	40	42	PSTX45-690-70	1SFA898205R7000	6.10	(13.45)
30	37	55	60	20	20	40	50	60	PSTX60-690-70	1SFA898206R7000	6.10	(13.45)
37	45	59	72	20	25	50	60	68	PSTX72-690-70	1SFA898207R7000	6.10	(13.45)
45	55	75	85	25	30	60	75	80	PSTX85-690-70	1SFA898208R7000	6.10	(13.45)
55	75	90	106	30	40	75	100	104	PSTX105-690-70	1SFA898209R7000	6.10	(13.45)
75	90	132	143	40	50	100	125	130	PSTX142-690-70	1SFA898210R7000	9.60	(21.16)
90	110	160	171	50	60	125	150	169	PSTX170-690-70	1SFA898211R7000	9.60	(21.16)
110	132	184	210	60	75	150	200	192	PSTX210-690-70	1SFA898212R7000	12.70	(27.99)
132	160	220	250	75	100	200	250	248	PSTX250-690-70	1SFA898213R7000	12.70	(27.99)
160	200	257	300	100	100	250	300	302	PSTX300-690-70	1SFA898214R7000	12.70	(27.99)
200	257	355	370	125	150	300	350	361	PSTX370-690-70	1SFA898215R7000	12.70	(27.99)
250	315	450	470	150	200	400	500	480	PSTB470-690-70	1SFA895016R7000	31.00	(68.34)
315	400	560	570	200	250	500	600	590	PSTB570-690-70	1SFA895017R7000	52.00	(114.64)
400	500	710	720	250	300	600	700	720	PSTB720-690-70	1SFA895018R7000	55.00	(121.25)
450	600	800	840	300	350	700	800	840	PSTB840-690-70	1SFA895019R7000	60.00	(132.28)
560	730	1000	1050	400	450	900	1000	1062	PSTB1050-690-70	1SFA895020R7000	60.00	(132.28)



# PSTX30 ... PSTB1050 – The advanced range Heavy-duty, class 30, in-line, ordering details



1SFC132038V0001

PSTX30 ... PSTX105



1SFC132035V0001

PSTX142 ... PSTX170



1SFC132088V0001

PSTX210 ... PSTX370



1SFC132088F0002

PSTB470



1SFC132088F0002

PSTB570 ... PSTB1050

## Description

Selection table for heavy-duty start. Typical applications:

- Centrifugal fan
- Conveyor belt (long)
- Crusher
- Mill
- Mixer
- Stirrer

If more than 10 starts/h, select one size larger than the standard selection. For a more precise selection, use the softstarter selection tool available at [www.abb.com/lowvoltage](http://www.abb.com/lowvoltage).

### Rated operational voltage $U_e$ , 208-600 V

#### Rated control supply voltage $U_s$ , 100-250 V AC, 50/60 Hz

IEC				UL/CSA					Type	Order code	Weight (1 pce)	
Rated operational power		current		Rated operational power		current					kg	(lb)
400 V	500 V	690 V		200 / 208 V	220 / 240 V	440 / 480 V	550 / 600 V					
$P_e$	$P_e$	$P_e$	$I_e$	$P_e$	$P_e$	$P_e$	$P_e$	FLA				
kW	kW	kW	A	hp	hp	hp	hp	A			kg	(lb)
11	15	-	22	5	7.5	15	20	25	PSTX30-600-70	1SFA898103R7000	6.10	(13.45)
15	18.5	-	30	7.5	10	20	25	28	PSTX37-600-70	1SFA898104R7000	6.10	(13.45)
18.5	22	-	37	10	10	25	30	34	PSTX45-600-70	1SFA898105R7000	6.10	(13.45)
22	25	-	45	10	15	30	40	42	PSTX60-600-70	1SFA898106R7000	6.10	(13.45)
30	37	-	60	20	20	40	50	60	PSTX72-600-70	1SFA898107R7000	6.10	(13.45)
37	45	-	72	20	25	50	60	68	PSTX85-600-70	1SFA898108R7000	6.10	(13.45)
45	55	-	85	25	30	60	75	80	PSTX105-600-70	1SFA898109R7000	6.10	(13.45)
55	75	-	106	30	40	75	100	104	PSTX142-600-70	1SFA898110R7000	9.60	(21.16)
75	90	-	143	40	50	100	125	130	PSTX170-600-70	1SFA898111R7000	9.60	(21.16)
90	110	-	171	50	60	125	150	169	PSTX210-600-70	1SFA898112R7000	12.70	(27.99)
110	132	-	210	60	75	150	200	192	PSTX250-600-70	1SFA898113R7000	12.70	(27.99)
132	160	-	250	75	100	200	250	248	PSTX300-600-70	1SFA898114R7000	12.70	(27.99)
160	200	-	300	100	100	250	300	302	PSTX370-600-70	1SFA898115R7000	12.70	(27.99)
200	257	-	370	125	150	300	350	361	PSTB470-600-70	1SFA894016R7000	31.00	(68.34)
250	315	-	470	150	200	400	500	480	PSTB570-600-70	1SFA894017R7000	52.00	(114.64)
315	400	-	570	200	250	500	600	590	PSTB720-600-70	1SFA894018R7000	55.00	(121.25)
400	500	-	720	250	300	600	700	720	PSTB840-600-70	1SFA894019R7000	60.00	(132.28)
450	600	-	840	300	350	700	800	840	PSTB1050-600-70	1SFA894020R7000	60.00	(132.28)

### Rated operational voltage $U_e$ , 208-690 V

#### Rated control supply voltage $U_s$ , 100-250 V AC, 50/60 Hz

11	15	18.5	22	5	7.5	15	20	25	PSTX30-690-70	1SFA898203R7000	6.10	(13.45)
15	18.5	25	30	7.5	10	20	25	28	PSTX37-690-70	1SFA898204R7000	6.10	(13.45)
18.5	22	30	37	10	10	25	30	34	PSTX45-690-70	1SFA898205R7000	6.10	(13.45)
22	25	37	44	10	15	30	40	42	PSTX60-690-70	1SFA898206R7000	6.10	(13.45)
30	37	55	60	20	20	40	50	60	PSTX72-690-70	1SFA898207R7000	6.10	(13.45)
37	45	59	72	20	25	50	60	68	PSTX85-690-70	1SFA898208R7000	6.10	(13.45)
45	55	75	85	25	30	60	75	80	PSTX105-690-70	1SFA898209R7000	6.10	(13.45)
55	75	90	106	30	40	75	100	104	PSTX142-690-70	1SFA898210R7000	9.60	(21.16)
75	90	132	143	40	50	100	125	130	PSTX170-690-70	1SFA898211R7000	9.60	(21.16)
90	110	160	171	50	60	125	150	169	PSTX210-690-70	1SFA898212R7000	12.70	(27.99)
110	132	184	210	60	75	150	200	192	PSTX250-690-70	1SFA898213R7000	12.70	(27.99)
132	160	220	250	75	100	200	250	248	PSTX300-690-70	1SFA898214R7000	12.70	(27.99)
160	200	257	300	100	100	250	300	302	PSTX370-690-70	1SFA898215R7000	12.70	(27.99)
200	257	355	370	125	150	300	350	361	PSTB470-690-70	1SFA895016R7000	31.00	(68.34)
250	315	450	470	150	200	400	500	480	PSTB570-690-70	1SFA895017R7000	52.00	(114.64)
315	400	560	570	200	250	500	600	590	PSTB720-690-70	1SFA895018R7000	55.00	(121.25)
400	500	710	720	250	300	600	700	720	PSTB840-690-70	1SFA895019R7000	60.00	(132.28)
450	600	800	840	300	350	700	800	840	PSTB1050-690-70	1SFA895020R7000	60.00	(132.28)

# PSTX30 ... PSTB1050 – The advanced range

## Normal starts, class 10, inside delta, ordering details

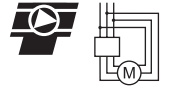

PSTX30 ... PSTX105

ISFC132038V0001

### Description

Selection table for normal start. Typical applications:

- Bow thruster
- Centrifugal pump
- Compressor
- Conveyor belt (short)
- Elevator
- Escalator

If more than 10 starts/h, select one size larger than the standard selection. For a more precise selection, use the softstarter selection tool available at [www.abb.com/lowvoltage](http://www.abb.com/lowvoltage).



PSTX142 ... PSTX170

ISFC132033V0001



PSTX210 ... PSTX370

ISFC132036V0001



PSTB470

ISFC132039F0002



PSTB570 ... PSTB1050

ISFC132039F0002

### Rated operational voltage $U_e$ , 208-600 V

### Rated control supply voltage $U_s$ , 100-250 V AC, 50/60 Hz

IEC				UL/CSA				Type	Order code	Weight (1 pce)			
Rated operational power				Rated operational power				current	FLA			kg	(lb)
$P_e$	$P_e$	$P_e$	$I_e$	200 / 208 V	220 / 240 V	440 / 480 V	550 / 600 V						
kW	kW	kW	A	hp	hp	hp	hp						
25	30	-	52	10	15	30	40	48	PSTX30-600-70	1SFA898103R7000	6.10	(13.45)	
30	37	-	64	15	20	40	50	58	PSTX37-600-70	1SFA898104R7000	6.10	(13.45)	
37	45	-	76	20	25	50	60	72	PSTX45-600-70	1SFA898105R7000	6.10	(13.45)	
55	75	-	105	30	40	75	100	103	PSTX60-600-70	1SFA898106R7000	6.10	(13.45)	
59	80	-	124	30	40	75	100	117	PSTX72-600-70	1SFA898107R7000	6.10	(13.45)	
75	90	-	147	40	50	100	125	138	PSTX85-600-70	1SFA898108R7000	6.10	(13.45)	
90	110	-	181	60	60	150	150	180	PSTX105-600-70	1SFA898109R7000	6.10	(13.45)	
132	160	-	245	75	75	150	200	225	PSTX142-600-70	1SFA898110R7000	9.60	(21.16)	
160	200	-	300	75	100	200	250	292	PSTX170-600-70	1SFA898111R7000	9.60	(21.16)	
184	250	-	360	100	125	250	300	332	PSTX210-600-70	1SFA898112R7000	12.70	(27.99)	
220	295	-	430	150	150	350	450	429	PSTX250-600-70	1SFA898113R7000	12.70	(27.99)	
257	355	-	515	150	200	450	500	523	PSTX300-600-70	1SFA898114R7000	12.70	(27.99)	
355	450	-	640	200	250	500	600	625	PSTX370-600-70	1SFA898115R7000	12.70	(27.99)	
450	600	-	814	250	300	600	700	720	PSTB470-600-70	1SFA894016R7000	31.00	(68.34)	
540	700	-	987	300	350	700	800	840	PSTB570-600-70	1SFA894017R7000	31.00	(114.64)	
710	880	-	1247	400	500	1000	1200	1247	PSTB720-600-70	1SFA894018R7000	52.00	(121.25)	
800	1000	-	1455	500	600	1200	1500	1454	PSTB840-600-70	1SFA894019R7000	55.00	(132.28)	
1000	1250	-	1810	600	700	1500	1800	1839	PSTB1050-600-70	1SFA894020R7000	60.00	(132.28)	

### Rated operational voltage $U_e$ , 208-690 V

### Rated control supply voltage $U_s$ , 100-250 V AC, 50/60 Hz

25	30	45	52	10	15	30	40	48	PSTX30-690-70	1SFA898203R7000	6.10	(13.45)
30	37	55	64	15	20	40	50	58	PSTX37-690-70	1SFA898204R7000	6.10	(13.45)
37	45	59	76	20	25	50	60	72	PSTX45-690-70	1SFA898205R7000	6.10	(13.45)
55	75	90	105	30	40	75	100	103	PSTX60-690-70	1SFA898206R7000	6.10	(13.45)
59	80	110	124	30	40	75	100	117	PSTX72-690-70	1SFA898207R7000	6.10	(13.45)
75	90	132	147	40	50	100	125	138	PSTX85-690-70	1SFA898208R7000	6.10	(13.45)
90	110	160	181	60	60	150	150	180	PSTX105-690-70	1SFA898209R7000	6.10	(13.45)
132	160	220	245	75	75	150	200	225	PSTX142-690-70	1SFA898210R7000	9.60	(21.16)
160	200	257	300	75	100	200	250	292	PSTX170-690-70	1SFA898211R7000	9.60	(21.16)
184	250	315	360	100	125	250	300	332	PSTX210-690-70	1SFA898212R7000	12.70	(27.99)
220	295	400	430	150	150	350	450	429	PSTX250-690-70	1SFA898213R7000	12.70	(27.99)
257	355	500	515	150	200	450	500	523	PSTX300-690-70	1SFA898214R7000	12.70	(27.99)
355	450	600	640	200	250	500	600	625	PSTX370-690-70	1SFA898215R7000	12.70	(27.99)
450	600	800	814	250	300	600	700	720	PSTB470-690-70	1SFA895016R7000	31.00	(68.34)
540	700	960	987	300	350	700	800	840	PSTB570-690-70	1SFA895017R7000	31.00	(114.64)
710	880	1200	1247	400	500	1000	1200	1247	PSTB720-690-70	1SFA895018R7000	52.00	(121.25)
800	1000	1400	1455	500	600	1200	1500	1454	PSTB840-690-70	1SFA895019R7000	55.00	(132.28)
1000	1250	1700	1810	600	700	1500	1800	1839	PSTB1050-690-70	1SFA895020R7000	60.00	(132.28)

# PSTX30 ... PSTB1050 – The advanced range Heavy-duty, class 30, inside delta, ordering details



PSTX30 ... PSTX105

## Description

Selection table for heavy-duty start. Typical applications:

- Centrifugal fan
- Conveyor belt (long)
- Crusher
- Mill
- Mixer
- Stirrer

If more than 10 starts/h, select one size larger than the standard selection. For a more precise selection, use the softstarter selection tool available at [www.abb.com/lowvoltage](http://www.abb.com/lowvoltage).



PSTX142 ... PSTX170



PSTX210 ... PSTX370



PSTB470



PSTB570 ... PSTB1050

### Rated operational voltage $U_e$ , 208-600 V

#### Rated control supply voltage $U_s$ , 100-250 V AC, 50/60 Hz

IEC		UL/CSA				Type	Order code	Weight				
Rated operational power		Rated operational current							(1 pce)			
400 V	500 V	690 V		200 / 208 V	220 / 240 V	440 / 480 V	550 / 600 V					
$P_e$	$P_e$	$P_e$	$I_e$	$P_e$	$P_e$	$P_e$	$P_e$	FLA				
kW	kW	kW	A	hp	hp	hp	hp	A	kg	(lb)		
18.5	25	-	42	7.5	10	25	30	34	PSTX30-600-70	1SFA898103R7000	6.10	(13.45)
25	30	-	52	10	15	30	40	48	PSTX37-600-70	1SFA898104R7000	6.10	(13.45)
30	37	-	64	15	20	40	50	58	PSTX45-600-70	1SFA898105R7000	6.10	(13.45)
37	45	-	76	20	25	50	60	72	PSTX60-600-70	1SFA898106R7000	6.10	(13.45)
55	75	-	105	30	40	75	100	103	PSTX72-600-70	1SFA898107R7000	6.10	(13.45)
59	80	-	124	30	40	75	100	117	PSTX85-600-70	1SFA898108R7000	6.10	(13.45)
75	90	-	147	40	50	100	125	138	PSTX105-600-70	1SFA898109R7000	6.10	(13.45)
90	110	-	181	60	60	150	150	180	PSTX142-600-70	1SFA898110R7000	9.60	(21.16)
132	160	-	245	75	75	150	200	225	PSTX170-600-70	1SFA898111R7000	9.60	(21.16)
160	200	-	300	75	100	200	250	292	PSTX210-600-70	1SFA898112R7000	12.70	(27.99)
184	250	-	360	100	125	250	300	332	PSTX250-600-70	1SFA898113R7000	12.70	(27.99)
220	295	-	430	150	150	350	450	429	PSTX300-600-70	1SFA898114R7000	12.70	(27.99)
257	355	-	515	150	200	450	500	523	PSTX370-600-70	1SFA898115R7000	12.70	(27.99)
355	450	-	640	200	250	500	600	625	PSTX470-600-70	1SFA894016R7000	31.00	(68.34)
450	600	-	814	250	300	600	700	720	PSTB570-600-70	1SFA894017R7000	31.00	(114.64)
540	700	-	987	300	350	700	800	840	PSTB720-600-70	1SFA894018R7000	52.00	(121.25)
710	880	-	1247	400	500	1000	1200	1247	PSTB840-600-70	1SFA894019R7000	55.00	(132.28)
800	1000	-	1455	500	600	1200	1500	1454	PSTB1050-600-70	1SFA894020R7000	60.00	(132.28)

### Rated operational voltage $U_e$ , 208-690 V

#### Rated control supply voltage $U_s$ , 100-250 V AC, 50/60 Hz

18.5	25	37	42	7.5	10	25	30	34	PSTX30-690-70	1SFA898203R7000	6.10	(13.45)
25	30	45	52	10	15	30	40	48	PSTX37-690-70	1SFA898204R7000	6.10	(13.45)
30	37	55	64	15	20	40	50	58	PSTX45-690-70	1SFA898205R7000	6.10	(13.45)
37	45	59	76	20	25	50	60	72	PSTX60-690-70	1SFA898206R7000	6.10	(13.45)
55	75	90	105	30	40	75	100	103	PSTX72-690-70	1SFA898207R7000	6.10	(13.45)
59	80	110	124	30	40	75	100	117	PSTX85-690-70	1SFA898208R7000	6.10	(13.45)
75	90	132	147	40	50	100	125	138	PSTX105-690-70	1SFA898209R7000	6.10	(13.45)
90	110	160	181	60	60	150	150	180	PSTX142-690-70	1SFA898210R7000	9.60	(21.16)
132	160	220	245	75	75	150	200	225	PSTX170-690-70	1SFA898211R7000	9.60	(21.16)
160	200	257	300	75	100	200	250	292	PSTX210-690-70	1SFA898212R7000	12.70	(27.99)
184	250	315	360	100	125	250	300	332	PSTX250-690-70	1SFA898213R7000	12.70	(27.99)
220	295	400	430	150	150	350	450	429	PSTX300-690-70	1SFA898214R7000	12.70	(27.99)
257	355	500	515	150	200	450	500	523	PSTX370-690-70	1SFA898215R7000	12.70	(27.99)
355	450	600	640	200	250	500	600	625	PSTB470-690-70	1SFA895016R7000	31.00	(68.34)
450	600	800	814	250	300	600	700	720	PSTB570-690-70	1SFA895017R7000	31.00	(114.64)
540	700	960	987	300	350	700	800	840	PSTB720-690-70	1SFA895018R7000	52.00	(121.25)
710	880	1200	1247	400	500	1000	1200	1247	PSTB840-690-70	1SFA895019R7000	55.00	(132.28)
800	1000	1400	1455	500	600	1200	1500	1454	PSTB1050-690-70	1SFA895020R7000	60.00	(132.28)



# PSTX – The advanced range Accessories



1SFT98099-095C2

SB8054C2

LZ...

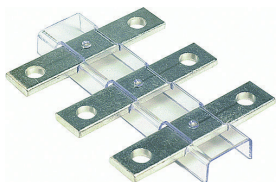

LX...

1SFT98000-012C3

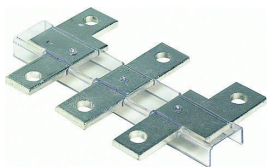

LW...

1SFT98009-011C3



LE460

1SFC132322F0002

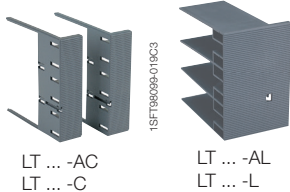

LT ... -AC  
LT ... -C

LT ... -AL  
LT ... -L

1SFT98099-019C3

1SFT98099-125



PSTEK

1SFC132119F0202

For softstarter type	Wire range	Tightening torque max.	Type	Order code	Pkg qty	Weight (1 pce)	
	mm <sup>2</sup>					Nm	kg

### Cable connectors for Cu cables

PSTX142 ... PSTX170	6-120	8	-	1SDA066917R1	3	0.113	(0.249)
PSTX142 ... PSTX170	2 x (50-95)	16	LZ185-2C/120	1SFN074709R1000	3	0.300	(0.661)
PSTX210 ... PSTX370	16-240	25	-	1SDA055016R1	3	0.133	(0.293)
PSTX210 ... PSTX370	2 x (70-185)	22	OZXB4	1SCA022194R0890	3	0.570	(1.257)
PSTB470	2 x (120-240)	35	-	1SDA013922R1	3	0.570	(1.257)
PSTB570 ... PSTB1050	3 x (70-185)	45	-	1SDA013956R1	3	0.570	(1.257)

### Cable connectors for Al cables

PSTX142 ... PSTX170	95-185	31	-	1SDA054988R1	3	0.078	(0.172)
PSTX210 ... PSTX370	185-240	43	-	1SDA055020R1	3	0.133	(0.293)
PSTB470 ... PSTB1050	3 x (70-185)	43	-	1SDA023384R0001	3	0.265	(0.584)
PSTB470 ... PSTB1050	2 x (120-240)	31	-	1SDA023380R0001	3	0.110	(0.243)

For softstarter type	Dimensions hole ø	bar mm	Type	Order code	Pkg qty	Weight (1 pce)	
	mm <sup>2</sup>					kg	(lb)

### Terminal extensions

PSTX142 ... PSTX170	8.5	17.5 x 5	LX205	1SFN074810R1000	1	0.250	(5.551)
PSTX210 ... PSTX370	10.5	20 x 5	LX370	1SFN075110R1000	1	0.350	(0.772)
PSTB470	10.5	25 x 5	LX460	1SFN075710R1000	1	0.500	(1.102)
PSTB570 ... PSTB1050	13	40 x 6	LX750	1SFN076110R1003	1	0.850	(1.874)

### Terminal enlargements

PSTX30 ... PSTX105	6.5	15 x 3	LW110	1SFN074307R1000	1	0.100	(0.220)
PSTX142 ... PSTX170	10.5	17.5 x 5	LW205	1SFN074807R1000	1	0.250	(5.551)
PSTX210 ... PSTX370	10.5	20 x 5	LW370	1SFN075407R1000	1	0.450	(0.992)
PSTB470	10.5	25 x 5	LW460	1SFN075707R1000	1	0.730	(1.609)
PSTB570 ... PSTB150	13	40 x 6	LW750	1SFN076107R1000	1	1.230	(2.712)

For softstarter type	Req. qty	Type	Order code	Pkg qty	Weight (1 pce)	
					kg	(lb)

### Terminal nut washer

PSTB470	6	LE460	1SFN075716R1000	6	0.600	(1.323)
PSTB570 ... PSTB1050	6	LE750	1SFN076116R1000	6	0.750	(1.653)

### Terminal shrouds

PSTX142 ... PSTX170, short for use with cable clamps	2	LT205-30C	1SFN124801R1000	2	0.050	(0.110)
PSTX142 ... PSTX170, long for use with compression lugs	2	LT205-30L	1SFN124803R1000	2	0.220	(0.485)
PSTX210 ... PSTX370, short for use with cable clamps	2	LT370-30C	1SFN125401R1000	2	0.035	(0.077)
PSTX210 ... PSTX370, long for use with compression lugs	2	LT370-30L	1SFN125403R1000	2	0.280	(0.617)
PSTX210 ... PSTX370, long and deep for use with extending cable clamps, ATK300/2 and OZXB4	2	LT370-30D	1SFN125406R1000	2	0.150	(0.331)
PSTB470, short for use with cable clamps	2	LT460-AC	1SFN125701R1000	2	0.100	(0.220)
PSTB470, long for use with compression lugs	2	LT460-AL	1SFN125703R1000	2	0.800	(1.764)
PSTB570 ... PSTB1050, short for use with cable clamps	2	LT750-AC	1SFN126101R1000	2	0.120	(0.265)
PSTB570 ... PSTB1050, long for use with compression lugs	2	LT750-AL	1SFN126103R1000	2	0.825	(1.819)

For softstarter type	Type	Order code	Pkg qty	Weight (1 pce)	
				kg	(lb)

### External keypad for PSTB including a 3 m cable

PSTB470 ... PSTB1050	PSTEK	1SFA899003R1000	1	0.400	(0.881)
----------------------	-------	-----------------	---	-------	---------

### Anybus connection accessory

Anybus suitable for PSTX30 ... PSTX370, See page 18

### FieldBusPlug connection accessory

PSTX30 ... PSTX370	PS-FBPA	1SFA896312R1002	1	0.060	(0.132)
ABB's FieldBusPlug suitable for all sizes, See catalog 1SFC132005C0201					

### I/O module, 24 V DC digital input

PSTX30 ... PSTX370	DX111-FBP.0	1SAJ611000R0101	1	0.220	(0.485)
--------------------	-------------	-----------------	---	-------	---------

# PSTX – The advanced range

## Technical data

### Tripping curves for the integrated electronic overload protection

All units have an integrated electronic overload protection that can be set to four different tripping classes. Below you find a curve for each tripping class in cold state. These tripping curves are valid for PSTX and PSTB.

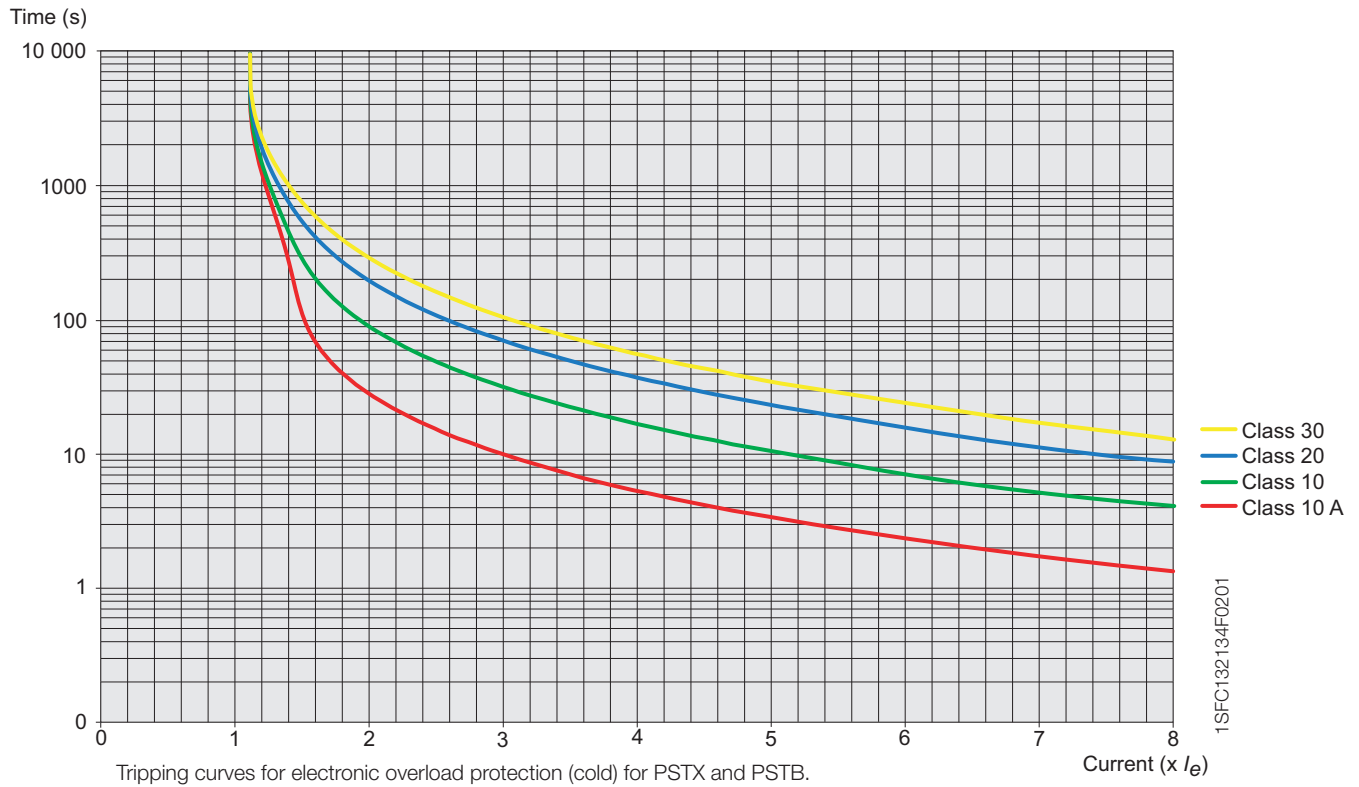

# PSTX – The advanced range

## Technical data

Softstarter types		PSTX30 ... PSTX370	PSTB470 ... PSTB1050	
Rated insulation voltage $U_i$		690V		
Rated operational voltage $U_e$		208...600 V, 208...690V + 10% / -15%, 50/60Hz ±5%		
Rated control supply voltage $U_s$		100...250 V +10% / -15%, 50/60Hz ±5%		
Rated control circuit voltage $U_c$		Internal or external 24 V DC		
Starting capacity at $I_e$		4 x $I_e$ for 10 sec.		
Number of starts per hour		10 <sup>1)</sup>		
Overload capability	Overload class	10		
	Ambient temperature	during operation	±0...+50 °C, (32...+122 F) <sup>2)</sup>	
		during storage	-25...+70 °C, (-13...+140 F) <sup>2)</sup>	
Maximum altitude		4000 m (13123 ft) <sup>3)</sup>		
Degree of protection	main circuit	-		
	Supply and control circuit	IP20	-	
Main circuit	Built-in bypass contactor	Yes		
	Cooling system - Fan cooled	Yes (thermostat controlled)		
	HMI for settings	LCD type, graphical	LCD type, full text	
(Human Machine Interface)	Display	English, German, Italian, Dutch, Chinese, Finnish, Swedish, French, Spanish, Russian, Portugese, Turkish, Polish and Czech		
	Keypad	2 selection keys, 4 navigation keys, start key, stop key, info key and remote/local key	2 selection keys and 2 navigation keys	
Signal relays	Number of programmable signal relays	3 (each relay can be programmed to be Run, Bypass or Event signal)		
	K4	Default as Run signal		
	K5	Default as Top of Ramp (Bypass) signal		
	K6	Default as Event signal		
	Rated operational voltage, $U_e$	250 V AC/24 V DC		
	Rated thermal current $I_{th}$	5 A		
Analog output	Rated operational current $I_e$ at AC-15 ( $U_e=250$ V)	1.5 A		
	Output signal reference	0...10 V, 0...20 mA, 4...20 mA		
Control circuit	Type of output signal	1 Amp, U Volt, P kW, P hp, Q kVar, TmpMot, TmpSCR, cosPhi		
	Number of inputs	2 (start, stop)		
Signalling indication LED	Number of additional programmable inputs	2 (Each input can be programmed to be either; Non, Reset, Enable, Jog, Direct on line-On, Start motor 2, Start motor 3 or FieldBus-disable)		
	Power on	Green		
	Run	Green	-	
	Fault	Red		
External keypad	Protection	Yellow		
	Detachable keypad	Yes	No	
	Display	LCD type, graphical	LCD type, full text	
	Ambient temperature			
	During operation	-25...+60 °C, (-13...+140 F)	±0...+50 °C, (32...+122 F)	
	During storage	-40...+70 °C, (-40...+158 F)	-25...+70 °C, (-13...+158 F)	
Start and stop functions	Degree of protection	IP66 (Type 1, 4X, 12)		
	Soft start with voltage ramp	Yes	Yes	
	Soft stop with voltage ramp	Yes	Yes	
	Soft start with torque control	Yes	Yes	
	Soft stop with torque control	Yes	Yes	
	Kick start	Yes	Yes	
	Full voltage start	Yes	No	
	Sequence start	Yes, 3 different sets of settings	Yes, 3 different sets of settings	
	Current limit	Yes	Yes	
	Dual current limit	Yes	Yes	
	Current ramp	Yes	No	
	Torque limit	Yes	Yes	
	Motor heating	Yes	No	
	Jog with slow speed	Yes	No	
	Limp mode with two-phase motor control if one set of thyristors is shorted	Yes	No	
	Field bus connection	Built-in Modbus RTU	Yes	No
		Connection for Anybus	Yes	No
		Connection for ABB FieldBusPlug	Yes, with adapter	Yes

<sup>1)</sup> Valid for 50% on time and 50% off time. If other data is required, contact your sales office.

<sup>2)</sup> Above 40 °C (104 F) reduce the rated current with 0,8% per °C (0,44% per F).

<sup>3)</sup> When used at high altitudes above 1000 meters (3281 ft) up to 4000 meters (13123 ft)

you need to derate the rated current using the following formula.

[ % of  $I_e = 100 - \frac{x-1000}{150} ] \times x =$  actual altitude for the softstarter, [ % of  $I_e = 100 - \frac{x-3280}{497} ] \times x =$  actual altitude for the softstarter in feet.

Softstarter types		PSTX30 ... PSTX370	PSTB470 ... PSTB1050	
<b>Protections</b>	Electronic overload protection, EOL	Yes (Class 10A, 10, 20, 30)	Yes (Class 10A, 10, 20, 30)	
	Dual overload (separate overload for start and run)	Yes	Yes	
	PTC connection	Yes	Yes	
	PT-100 connection	Yes	No	
	Locked rotor protection	Yes (Level and delay adjustable)	Yes (Level and delay adjustable)	
	Current underload protection	Yes (Level and delay adjustable)	Yes (Level and delay adjustable)	
	Current imbalance protection	Yes	Yes	
	Power factor underload protection	Yes	No	
	Under voltage protection	Yes	No	
	Over voltage protection	Yes	No	
	Voltage imbalance protection	Yes	No	
	Earth fault protection / ground fault protection	Yes	No	
	High current protection (8 x I <sub>e</sub> )	Yes	Yes	
	Phase reversal protection	Yes	Yes	
	Fieldbus fault	Yes	No	
	<b>Warnings (pre-warning) and embedded diagnostics</b>	Current underload warning	Yes (level and delay adjustable)	Yes (level and delay adjustable)
		Current imbalance warning	Yes	No
Voltage imbalance warning		Yes	No	
Thyristor overload warning (SCR)		Yes	Yes	
Electronic overload Time-to-trip		Yes	No	
Electronic overload Time-to-cool		Yes	No	
Over voltage warning		Yes	No	
Under voltage warning		Yes	No	
Power factor underload warning		Yes	No	
Locked rotor warning		Yes	Yes	
Faulty fans		Yes	No	
THD(U) - Total Harmonic Distortion		Yes	No	
Counted number of start sequences		Yes	No	
Motor runtime measurement		Yes	No	
Thyristor runtime measurement		Yes	No	
Auto phase sequence detection		Yes	No	
<b>External faults detection</b>		Electricity metering	Yes	No
	Voltage sags detection	Yes	No	
	Phase loss	Yes	Yes	
	Hight current	Yes	No	
	Low control supply voltage	Yes	No	
	Open circuit motor side	Yes	Yes	
	Faulty connection	Yes	Yes	
<b>Internal faults detection</b>	Bad network quality	Yes	No	
	Thyristor overload	Yes	Yes	
	Short circuit	Yes	Yes	
	Open circuit thyristor or gate	Yes	No	
	Bypass open	Yes	Yes	
<b>PTC input</b>	Shunt fault	Yes	No	
	Switch off resistance	2825 ohm ± 20%	2825 ohm ± 20%	
	Switch on resistance	1200 ohm ± 20%	1200 ohm ± 20%	
<b>Other functions</b>	Event log	Yes	Yes	
	Real time clock	Yes	Yes	
	Keypad password	Yes	Yes	



# PSTX – The advanced range

## Technical data

### Fuse ratings and power losses

For softstarter	Recommended ABB's overload protection						Power requirements supply circuit Holding (VA) / Pull-in(VA)
	Type	Current range	Max power loss at rated I <sub>e</sub>		Max fuse rating - main circuit <sup>1)2)</sup> Bussmann fuses, DIN43 620 (Knife)		
			A	W	A	Type	
<b>PSTX</b>							
PSTX30	Integrated	9 - 30	0.8	100	170M1567	000	49/51
PSTX37	Integrated	11.1 - 37	1.2	125	170M1568	000	49/51
PSTX45	Integrated	13.5 - 45	1.8	160	170M1569	000	49/51
PSTX60	Integrated	18 - 60	3.2	160	170M1569	000	49/51
PSTX72	Integrated	21.6 - 72	4.7	250	170M1571	000	49/51
PSTX85	Integrated	22.5 - 85	6.5	315	170M1572	000	49/51
PSTX105	Integrated	31.8 - 106	10	400	170M3819	1*	49/51
PSTX142	Integrated	42.9 - 143	18	500	170M5810	2	49/53
PSTX170	Integrated	51.3 - 171	26	630	170M5812	2	49/53
PSTX210	Integrated	63 - 210	48	630	170M5812	2	56/276
PSTX250	Integrated	75 - 250	68	700	170M5813	2	56/276
PSTX300	Integrated	90 - 300	97	800	170M6812	3	56/276
PSTX370	Integrated	111 - 370	148	900	170M6813	3	56/276
<b>PSTB 600 V</b>							
PSTB470	Integrated	141 - 540	110	900	170M6813	3	20/480
PSTB570	Integrated	171 - 655	105	900	170M6813	3	25/900
PSTB720	Integrated	216 - 828	110	1250	170M8554	3	25/860
PSTB840	Integrated	252 - 966	170	1500	170M6018 <sup>3)</sup>	3	25/860
PSTB1050	Integrated	315 - 1207	170	1800	170M6020 <sup>3)</sup>	3	25/860
<b>PSTB 690 V</b>							
PSTB470	Integrated	141 - 540	110	900	170M6813	3	20/480
PSTB570	Integrated	171 - 655	105	900	170M6813	3	25/900
PSTB720	Integrated	216 - 828	110	1250	170M8554	3	25/860
PSTB840	Integrated	252 - 966	170	1500	170M6018 <sup>3)</sup>	3	25/860
PSTB1050	Integrated	315 - 1207	170	1600	170M6019 <sup>3)</sup>	3	25/860

<sup>1)</sup> For the supply circuit 6 A delayed, for MCB use C characteristics.

<sup>2)</sup> For inside delta connection the fuses shall be placed inside the delta. Contact ABB for more information.







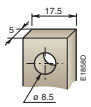
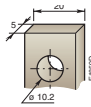
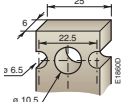
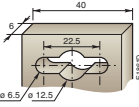

<sup>3)</sup> DIN43 653

### PSTB Integrated bypass ratings

Softstarter	PSTB470	PSTB570	PSTB720	PSTB840	PSTB1050
Integrated contactor	AF300	AF460	AF580	AF750	
AC-3 rating (A)	305	460	580	750	

# PSTX – The advanced range

## Technical data

Main terminals			PSTX30 ... PSTX105	PSTX142 ... PSTX170	PSTX210 ... PSTX370	PSTB470	PSTB570 ... PSTB1050
							
	Cu cable - flexible	1 x mm <sup>2</sup>	10 - 70mm <sup>2</sup>	6 - 120 mm <sup>2</sup>	16 - 240 mm <sup>2</sup>	-	-
	Clamp type		Included	1SDA066917R1	1SDA055016R1	-	-
	Tightening torque		8 Nm	14 Nm	25 Nm	-	-
	Cu cable - flexible	2 x mm <sup>2</sup>	6 - 35 mm <sup>2</sup>	50 - 95 mm <sup>2</sup>	70 - 185 mm <sup>2</sup>	-	-
	Clamp type		Included	LZ185 - 2C/120, 1SFN074709R1000	OZXB4 <sup>1)</sup> , 1SCA022194R0890	-	-
	Tightening torque		8 Nm	14 Nm	22 Nm	-	-
	Cu cable - Stranded	1 x mm <sup>2</sup>	10 - 70 mm <sup>2</sup>	6 - 150 mm <sup>2</sup>	16 - 300 mm <sup>2</sup>	-	-
	Clamp type		Included	1SDA066917R1	1SDA055016R1	-	-
	Tightening torque		8 Nm	14 Nm	25 Nm	-	-
	Cu cable - Stranded	2 x mm <sup>2</sup>	6 - 35 mm <sup>2</sup>	50 - 120 mm <sup>2</sup>	70 - 185 mm <sup>2</sup>	120 - 240 mm <sup>2</sup>	-
	Clamp type		Included	LZ185 - 2C/120, 1SFN074709R1000	OZXB4 <sup>1)</sup> , 1SCA022194R0890	1SDA013922R1	-
	Tightening torque		8 Nm	16 Nm	22 Nm	35 Nm	-
	Cu cable - Stranded	3 x mm <sup>2</sup>	-	-	-	-	70 - 185 mm <sup>2</sup>
	Clamp type		-	-	-	-	1SDA013956R1
	Tightening torque		-	-	-	-	45 Nm
	Al cable - Stranded	1 x mm <sup>2</sup>	-	95 - 185 mm <sup>2</sup>	185 - 240 mm <sup>2</sup>	-	-
	Clamp type		-	1SDA0549881R1	1SDA055020R1	-	-
	Tightening torque		-	31 Nm	43 Nm	-	-
	Al cable - Stranded	2 x mm <sup>2</sup>	-	-	-	120 - 240 mm <sup>2</sup>	-
	Clamp type		-	-	-	1SDA023380R0001	-
	Tightening torque		-	-	-	31 Nm	-
	Lugs	Width ≤	-	24 mm (.945 in)	32 mm (1.260 in)	47 mm (1.850 in)	50 mm (1.969 in)
		Diameter =	-	8 mm (.315 in)	10 mm (.394 in)	10 mm (.394 in)	12 mm (.472 in)
		Tightening torque	-	18 Nm / 160 lb.in	28 Nm / 248 lb.in	35 Nm / 310 lb.in	45 Nm / 398 lb.in
Connection capacity acc to UL / CSA 1 x AWG / kcmil			6 - 2/0	6 - 300 kcmil	4 - 400 kcmil	-	-
	Clamp type		Included	ATK185	ATK300	-	-
	Tightening torque		8 Nm / 71 lb. in.	34 Nm / 300 lb.in.	42 Nm / 375 lb. in.	-	-
Connection capacity acc to UL / CSA 2 x AWG / kcmil			-	-	4 - 500 kcmil	2/0 - 500 kcmil	2/0 - 500 kcmil
	Clamp type		-	-	ATK300/2 <sup>2)</sup>	ATK580/2	ATK580/2
	Tightening torque		-	-	42 Nm / 375 lb. in.	42 Nm / 375 lb. in.	42 Nm / 375 lb. in.
Connection capacity acc to UL / CSA 3 x AWG / kcmil			-	-	-	-	2/0 - 500 kcmil
	Clamp type		-	-	-	-	ATK750/3
	Tightening torque		-	-	-	-	42 Nm / 375 lb.in
Connection capacity acc to UL / CSA 4 x AWG / kcmil			-	-	-	-	-
	Clamp type		-	-	-	-	-
	Tightening torque		-	-	-	-	-

<sup>1)</sup> Terminal shrouds 1SFN125406R1000 must be used.

<sup>2)</sup> Terminal shrouds 1SFN125406R1000 can be used.

# PSTX - The advanced range Anybus

For communication protocol	Type	Order code	Pack Qty	Weight (1 pce)	
				kg	(lb)
Profibus	AB-PROFIBUS-1	1SFA899300R1001	1	0.042	(0.093)
DeviceNet	AB-DEVICENET-1	1SFA899300R1002	1	0.042	(0.093)
Modbus-RTU	AB-MODBUS-RTU-1	1SFA899300R1003	1	0.042	(0.093)
EtherNet/IP (1-port)	AB-ETHERNET-IP-1	1SFA899300R1005	1	0.042	(0.093)
EtherNet/IP (2-port)	AB-ETHERNET-IP-2	1SFA899300R1006	1	0.042	(0.093)
Modbus/TCP (1-port)	AB-MODBUS-TCP-1	1SFA899300R1007	1	0.042	(0.093)
Modbus/TCP (2-port)	AB-MODBUS-TCP-2	1SFA899300R1008	1	0.042	(0.093)



# PSTX - The advanced range

## Wall mounting instructions

### Minimum distance to front

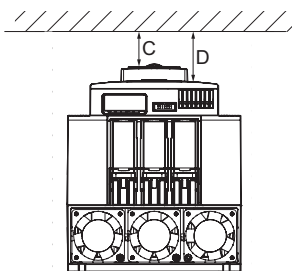

### Minimum distance to wall

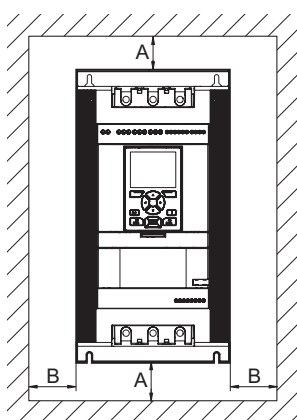

### Dimensions mm (in)

Softstarter, type	A	B	C	D
<b>PSTX</b>				
PSTX30 ... PSTX105	100 (3.937)	10 (0.393)	20 (0.787)	35 (1.378)
PSTX142 ... PSTX170	100 (3.937)	10 (0.393)	20 (0.787)	35 (1.378)
PSTX210 ... PSTX370	100 (3.937)	10 (0.393)	20 (0.787)	35 (1.378)
<b>PSTB</b>				
PSTB470	150 (5.905)	15 (0.590)	20 (0.787)	-
PSTB570 ... PSTB1050	150 (5.905)	15 (0.590)	20 (0.787)	-

### Maximum mounting angle

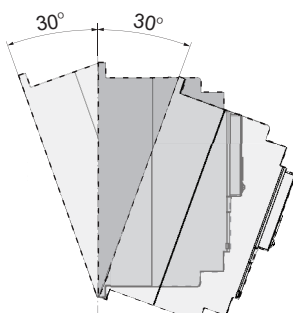
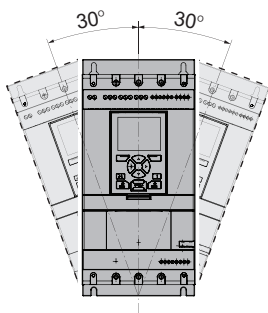

## Dimensions

### PSTB external keypad (PSTEK)

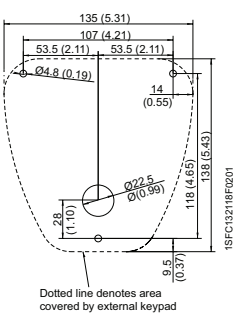
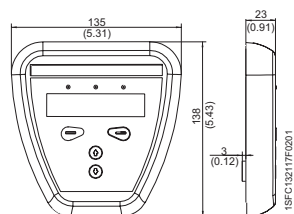

Dotted line denotes area covered by external keypad

### PSTX detachable keypad

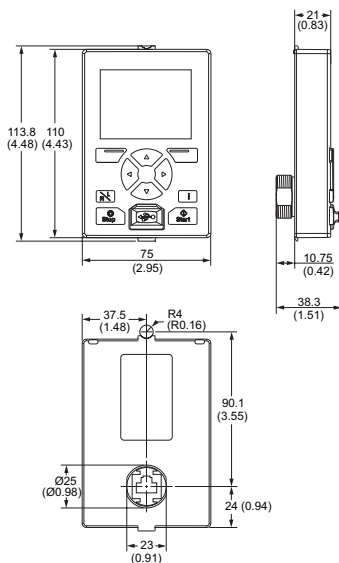

Dimensions in mm (in)

# PSTX - The advanced range

## Dimensions

PSTX30 ... PSTX105

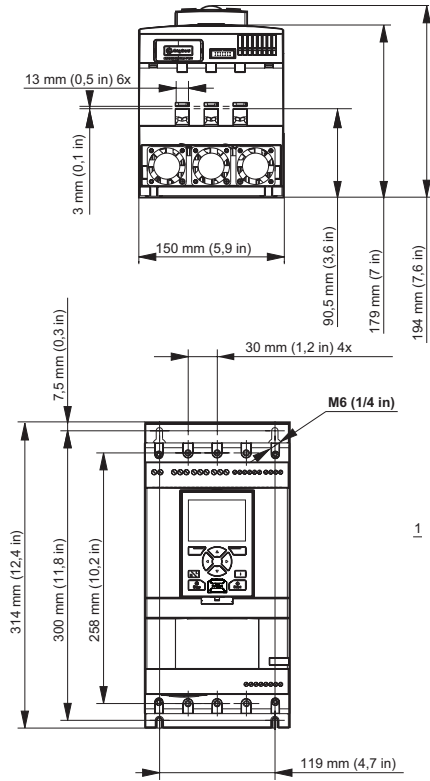

PSTX142 ... PSTX170

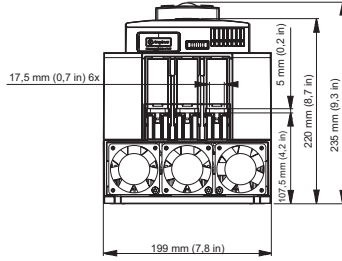

PSTX210 ... PSTX370

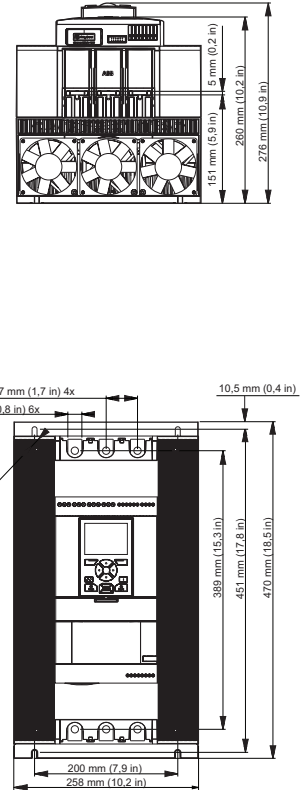

PSTB470

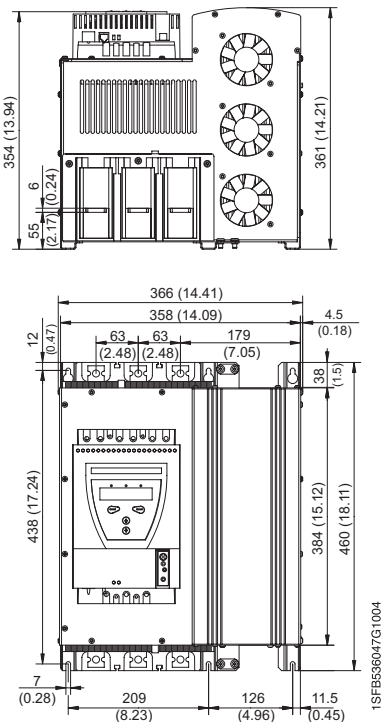

PSTB570 ... PSTB1050

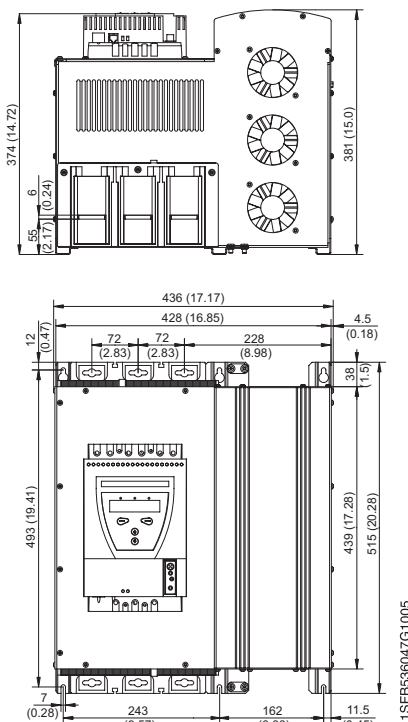

Dimensions in mm (in)

# PSTX - The advanced range

## Circuit diagrams PSTX



### CAUTION

Terminal 22 is a function earth, it is not a protective earth. It shall be connected to the mounting plate.

### PSTX30 ... PSTX370 (IEC circuit diagram)

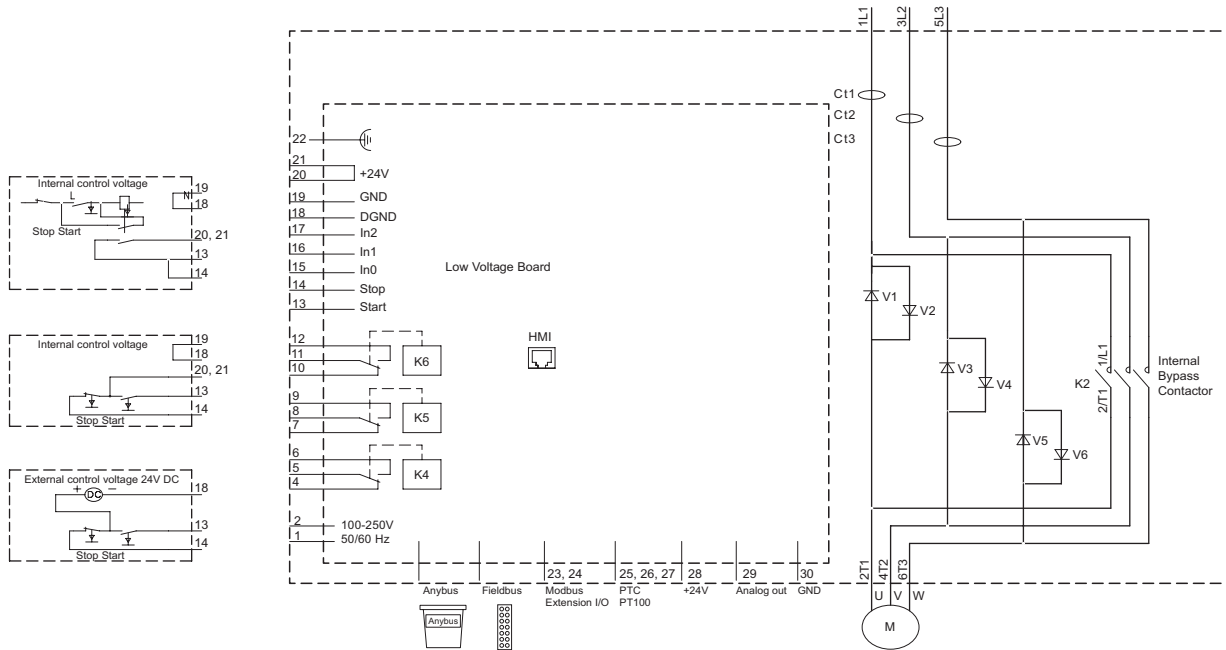

### PSTX30 ... PSTX370 (UL circuit diagram)

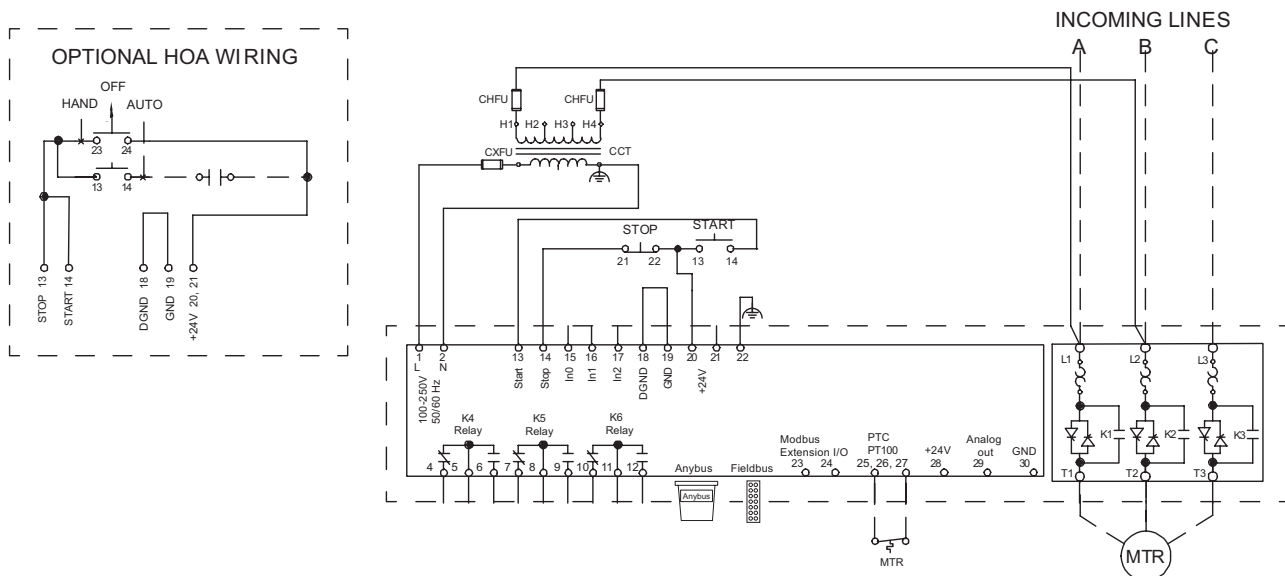

For more circuit diagrams see [www.abb.com/lowvoltage](http://www.abb.com/lowvoltage).

# PSTX - The advanced range

## Circuit diagrams PSTB

### PSTB470 ... PSTB1050

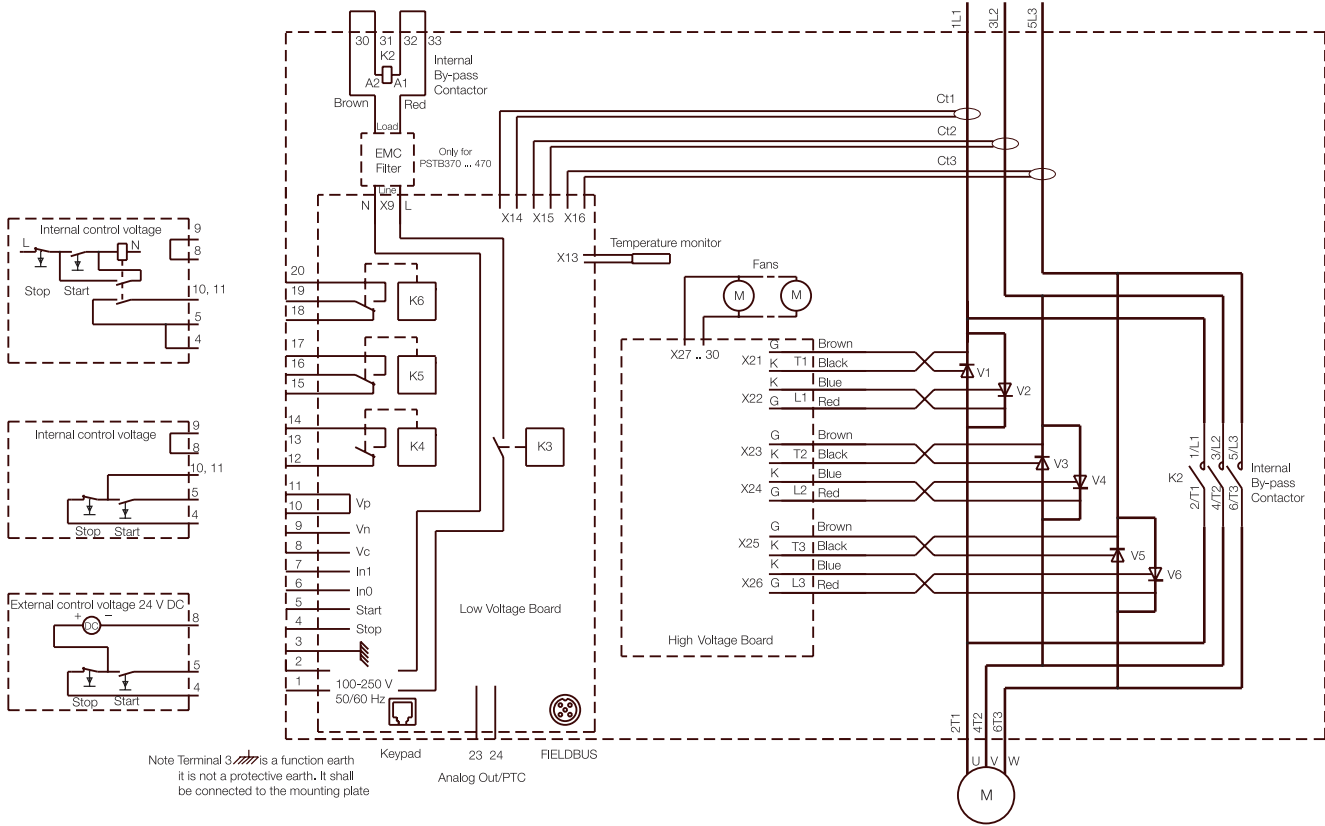

For more circuit diagrams see [www.abb.com/lowvoltage](http://www.abb.com/lowvoltage).







# PSTX - The advanced range

## Certifications and approvals

The table below shows the certifications and approvals for PSTX and PSTB softstarters. For other certifications and/or approvals, please contact ABB, [www.abb.com/lowvoltage](http://www.abb.com/lowvoltage).

### Certifications and approvals

Abbreviation approved in	Certifications						Approval: ship classification societies				
											
	CE EU	cULus Canada USA	CCC China	EAC Russia	ANCE Mexico	C-tick Australia	ABS	GL	Lloyd's Register	DNV	CCS
PSTX30 ... PSTX370	•	Pending	Pending	Pending	Pending	Pending	Pending	Pending	Pending	Pending	Pending
PSTB470 ... PSTB1050	•	•	•	GOST	•	•	•	•	-	-	-

• Standard design approved, the products bear the certification mark when it is required.

### Directives and standards

No. 2006/95/EC	Low voltage equipment
No. 2004/108/EC	Electromagnetic compability
EN 60947-1	Low-Voltage Switchgear and Controlgear - Part 1: General rules
EN 60947-4-2	AC semiconductor motor controllers and starters
UL 508	Industrial Control Equipment
CSA C22.2 No 14	Industrial Control Equipment

# Contact us

**ABB AB**

**Control Products**

**Low Voltage Products**

SE-721 61 VÄSTERÅS, Sweden

[www.abb.com/lowvoltage](http://www.abb.com/lowvoltage)

[www.abb.com/connecttocontrol](http://www.abb.com/connecttocontrol)

## Note

We reserve the right to make technical changes or modify the contents of this document without prior notice. With regard to purchase orders, the agreed particulars shall prevail. ABB does not accept any responsibility whatsoever for potential errors or possible lack of information in this document.

We reserve all rights in this document and in the subject matter and illustrations contained therein. Any reproduction, disclosure to third parties or utilization of its contents - in whole or in parts - is forbidden without prior written consent of ABB.

© Copyright 2014. All rights reserved.



To get more information, install QR code reader on your mobile device, scan the code and see more.